

**PI734D - Technical Data Sheet**

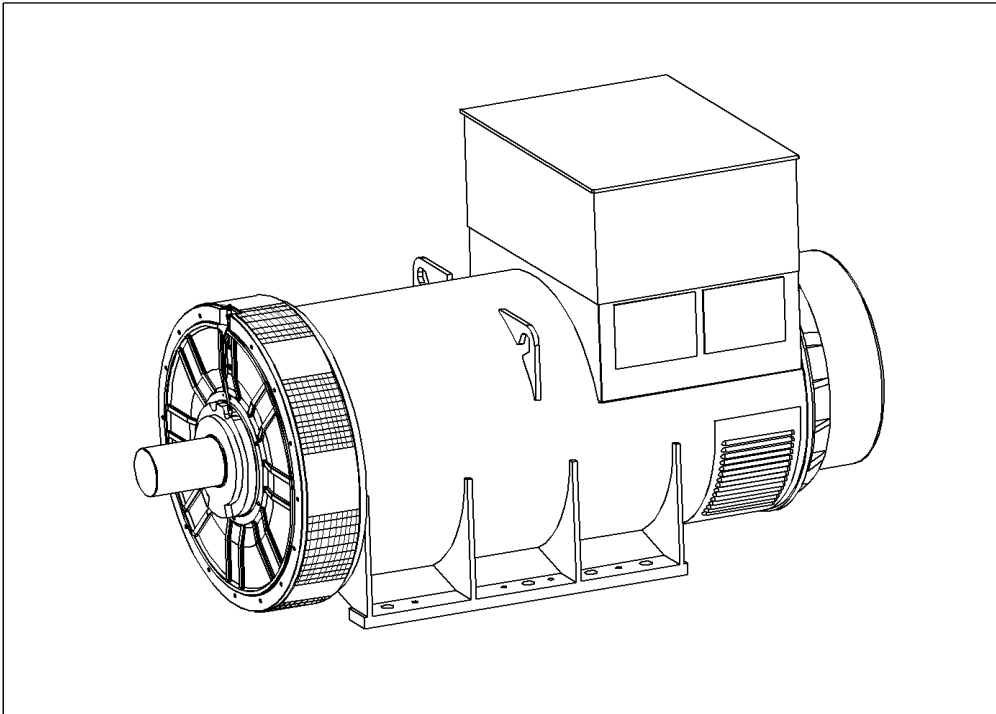

# PI734D

## SPECIFICATIONS & OPTIONS



### STANDARDS

Newage Stamford industrial generators meet the requirements of BS EN 60034 and the relevant sections of other national and international standards such as BS5000, VDE 0530, NEMA MG1-32, IEC60034, CSA C22.2-100, AS1359.

Other standards and certifications can be considered on request.

### DESCRIPTION

The STAMFORD PI range of synchronous ac generators are brushless with a rotating field. They are separately excited by the STAMFORD Permanent Magnet Generator (PMG). This is a shaft mounted, high frequency, pilot exciter which provides a constant supply of clean power via the Automatic Voltage Regulator (AVR) to the main exciter. The main exciter output is fed to the main rotor, through a full wave bridge rectifier, protected by surge suppression.

### VOLTAGE REGULATORS

The PI range generators, complete with a PMG, are available with one of two AVRs. Each AVR has soft start voltage build up and built in protection against sustained over-excitation, which will de-excite the generator after a minimum of 8 seconds.

Underspeed protection (UFRO) is also provided on both AVRs. The UFRO will reduce the generator output voltage proportional to the speed of the generator below a pre-settable level.

The **MX341 AVR** is two phase sensed with a voltage regulation of  $\pm 1\%$ . (see the note on regulation).

The **MX321 AVR** is 3 phase rms sensed with a voltage regulation of 0.5% rms (see the note on regulation). The UFRO circuit has adjustable slope and dwell for controlled recovery from step loads. An over voltage protection circuit will shutdown the output device of the AVR, it can also trip an optional excitation circuit breaker if required. As an option, short circuit current limiting is available with the addition of current transformers.

Both the MX341 and the MX321 need a generator mounted current transformer to provide quadrature droop characteristics for load sharing during parallel operation. Provision is also made for the connection of the STAMFORD power factor controller, for embedded applications, and a remote voltage trimmer.

### WINDINGS & ELECTRICAL PERFORMANCE

All generator stators are wound to 2/3 pitch. This eliminates triplen (3rd, 9th, 15th ...) harmonics on the voltage waveform and is found to be the optimum design for trouble-free supply of non-linear loads. The 2/3 pitch design avoids excessive neutral currents sometimes seen with higher winding pitches. A fully connected damper winding reduces oscillations during paralleling. This winding, with the 2/3 pitch and carefully selected pole and tooth designs, ensures very low levels of voltage waveform distortion.

### TERMINALS & TERMINAL BOX

Standard generators feature a main stator with 6 ends brought out to the terminals, which are mounted on the frame at the non-drive end of the generator. A sheet steel terminal box contains the AVR and provides ample space for the customers' wiring and gland arrangements. It has removable panels for easy access.

### SHAFT & KEYS

All generator rotors are dynamically balanced to better than BS6861:Part 1 Grade 2.5 for minimum vibration in operation. Two bearing generators are balanced with a half key.

### INSULATION/IMPREGNATION

The insulation system is class 'H', and meets the requirements of UL1446.

All wound components are impregnated with materials and processes designed specifically to provide the high build required for static windings and the high mechanical strength required for rotating components.

### QUALITY ASSURANCE

Generators are manufactured using production procedures having a quality assurance level to BS EN ISO 9001.

### NOTE ON REGULATION

The stated voltage regulation may not be maintained in the presence of certain radio transmitted signals. Any change in performance will fall within the limits of Criteria 'B' of EN 61000-6-2:2001. At no time will the steady-state voltage regulation exceed 2%.

Note: Continuous development of our products entitles us to change specification details without notice, therefore they must not be regarded as binding.

Front cover drawing is typical of the product range.

**PI734D**  
**WINDING 312**

|                         |                                                  |         |                          |
|-------------------------|--------------------------------------------------|---------|--------------------------|
| CONTROL SYSTEM          | SEPARATELY EXCITED BY P.M.G.                     |         |                          |
| A.V.R.                  | MX341                                            | MX321   |                          |
| VOLTAGE REGULATION      | ± 1 %                                            | ± 0.5 % | With 4% ENGINE GOVERNING |
| SUSTAINED SHORT CIRCUIT | REFER TO SHORT CIRCUIT DECREMENT CURVES (page 7) |         |                          |

|                           |                                                                                      |
|---------------------------|--------------------------------------------------------------------------------------|
| INSULATION SYSTEM         | CLASS H                                                                              |
| PROTECTION                | IP23                                                                                 |
| RATED POWER FACTOR        | 0.8                                                                                  |
| STATOR WINDING            | DOUBLE LAYER LAP                                                                     |
| WINDING PITCH             | TWO THIRDS                                                                           |
| WINDING LEADS             | 6                                                                                    |
| MAIN STATOR RESISTANCE    | 0.00114 Ohms PER PHASE AT 22°C STAR CONNECTED                                        |
| MAIN ROTOR RESISTANCE     | 1.98 Ohms at 22°C                                                                    |
| EXCITER STATOR RESISTANCE | 17.5 Ohms at 22°C                                                                    |
| EXCITER ROTOR RESISTANCE  | 0.048 Ohms PER PHASE AT 22°C                                                         |
| R.F.I. SUPPRESSION        | BS EN 61000-6-2 & BS EN 61000-6-4, VDE 0875G, VDE 0875N. refer to factory for others |
| WAVEFORM DISTORTION       | NO LOAD < 1.5% NON-DISTORTING BALANCED LINEAR LOAD < 5.0%                            |
| MAXIMUM OVERSPEED         | 2250 Rev/Min                                                                         |
| BEARING DRIVE END         | BALL. 6228 C3                                                                        |
| BEARING NON-DRIVE END     | BALL. 6319 C3                                                                        |

|                             | 1 BEARING                | 2 BEARING                |
|-----------------------------|--------------------------|--------------------------|
| WEIGHT COMP. GENERATOR      | 3318 kg                  | 3267 kg                  |
| WEIGHT WOUND STATOR         | 1619 kg                  | 1619 kg                  |
| WEIGHT WOUND ROTOR          | 1383 kg                  | 1321 kg                  |
| WR <sup>2</sup> INERTIA     | 41.2206 kgm <sup>2</sup> | 40.2197 kgm <sup>2</sup> |
| SHIPPING WEIGHTS in a crate | 3391kg                   | 3336kg                   |
| PACKING CRATE SIZE          | 216 x 105 x 154(cm)      | 216 x 105 x 154(cm)      |

|                                          | 50 Hz                             |         |         |         | 60 Hz                             |         |         |         |
|------------------------------------------|-----------------------------------|---------|---------|---------|-----------------------------------|---------|---------|---------|
| TELEPHONE INTERFERENCE                   | THF<2%                            |         |         |         | TIF<50                            |         |         |         |
| COOLING AIR                              | 2.69 m <sup>3</sup> /sec 5700 cfm |         |         |         | 3.45 m <sup>3</sup> /sec 7300 cfm |         |         |         |
| VOLTAGE STAR                             | 380/220                           | 400/231 | 415/240 | 440/254 | 416/240                           | 440/254 | 460/266 | 480/277 |
| KVA BASE RATING FOR REACTANCE VALUES     | 1615                              | 1650    | 1650    | 1620    | 1815                              | 1935    | 1975    | 2015    |
| X <sub>d</sub> DIR. AXIS SYNCHRONOUS     | 3.12                              | 2.88    | 2.67    | 2.33    | 3.75                              | 3.57    | 3.33    | 3.12    |
| X' <sub>d</sub> DIR. AXIS TRANSIENT      | 0.19                              | 0.18    | 0.16    | 0.14    | 0.23                              | 0.22    | 0.20    | 0.19    |
| X'' <sub>d</sub> DIR. AXIS SUBTRANSIENT  | 0.14                              | 0.13    | 0.12    | 0.11    | 0.17                              | 0.16    | 0.15    | 0.14    |
| X <sub>q</sub> QUAD. AXIS REACTANCE      | 2.01                              | 1.85    | 1.72    | 1.50    | 2.41                              | 2.30    | 2.15    | 2.01    |
| X'' <sub>q</sub> QUAD. AXIS SUBTRANSIENT | 0.28                              | 0.26    | 0.24    | 0.21    | 0.34                              | 0.32    | 0.30    | 0.28    |
| X <sub>L</sub> LEAKAGE REACTANCE         | 0.04                              | 0.03    | 0.03    | 0.03    | 0.04                              | 0.04    | 0.04    | 0.04    |
| X <sub>2</sub> NEGATIVE SEQUENCE         | 0.20                              | 0.18    | 0.17    | 0.15    | 0.24                              | 0.23    | 0.21    | 0.20    |
| X <sub>0</sub> ZERO SEQUENCE             | 0.02                              | 0.02    | 0.02    | 0.02    | 0.03                              | 0.03    | 0.03    | 0.02    |

REACTANCES ARE SATURATED

VALUES ARE PER UNIT AT RATING AND VOLTAGE INDICATED

|                                         |                  |
|-----------------------------------------|------------------|
| T' <sub>d</sub> TRANSIENT TIME CONST.   | 0.137s           |
| T'' <sub>d</sub> SUB-TRANSTIME CONST.   | 0.01s            |
| T' <sub>do</sub> O.C. FIELD TIME CONST. | 2.25s            |
| T <sub>a</sub> ARMATURE TIME CONST.     | 0.02s            |
| SHORT CIRCUIT RATIO                     | 1/X <sub>d</sub> |

**50  
Hz**

**PI734D**  
Winding 312



**THREE PHASE EFFICIENCY CURVES**

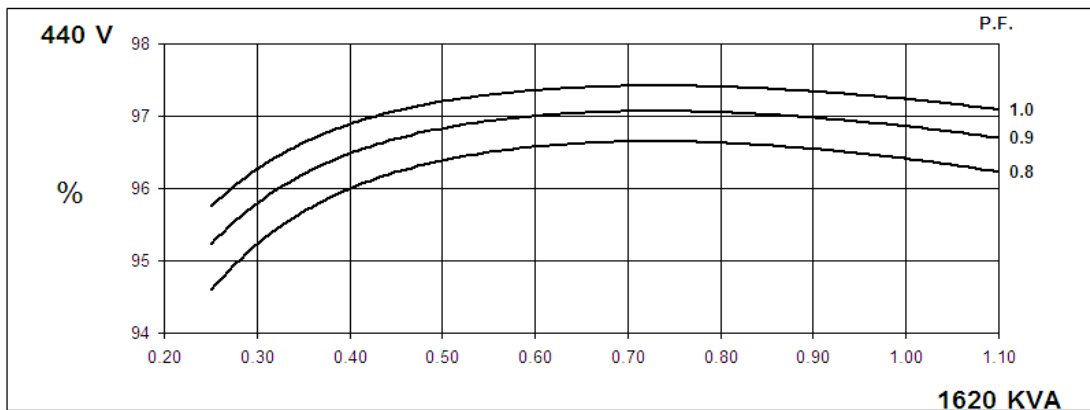
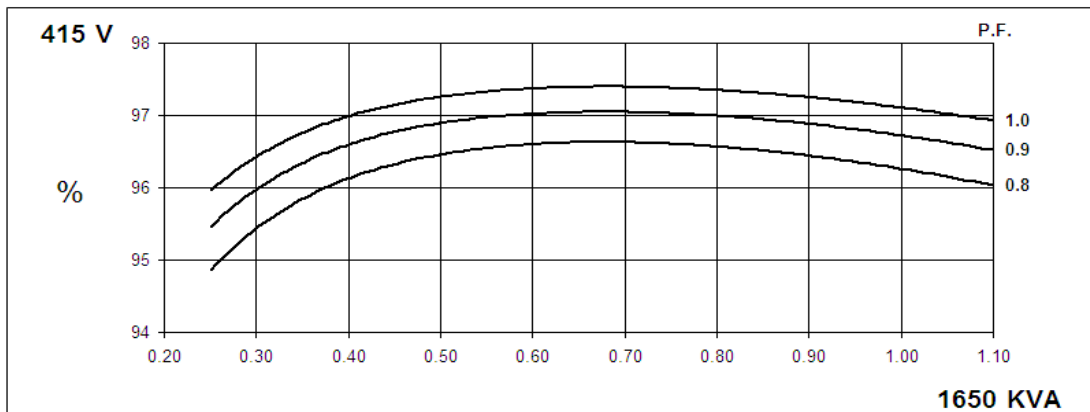
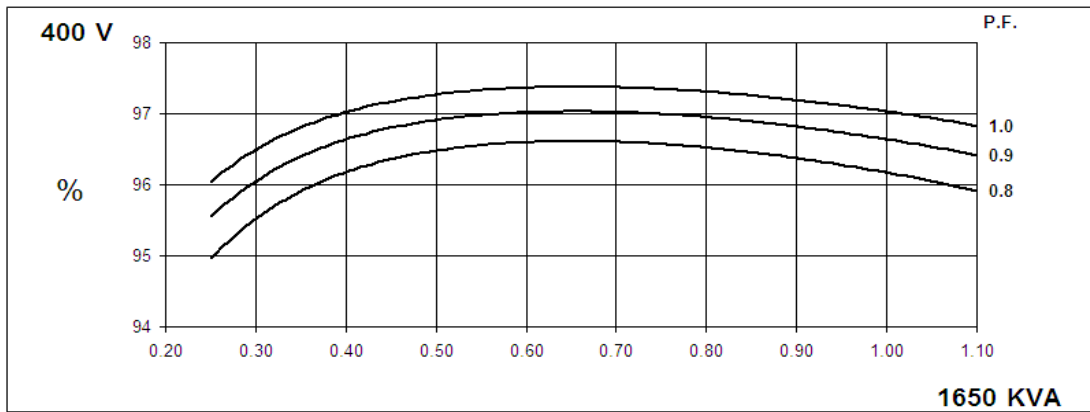
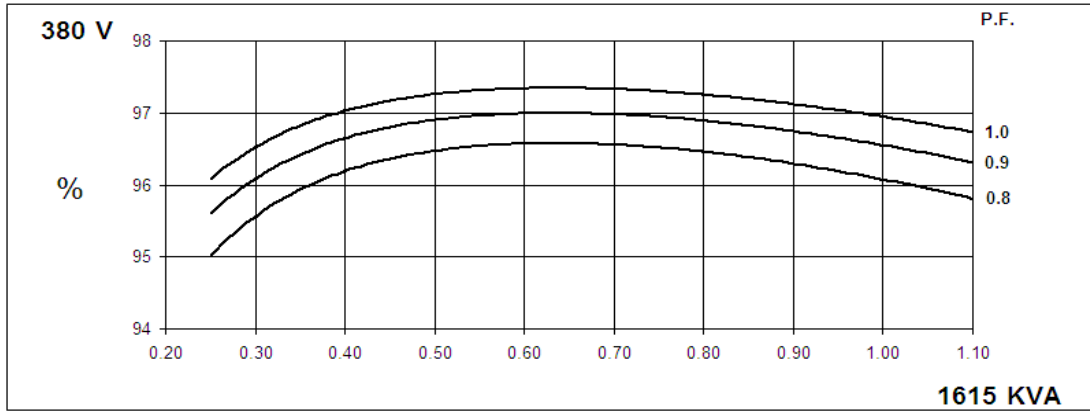

**THREE PHASE EFFICIENCY CURVES**

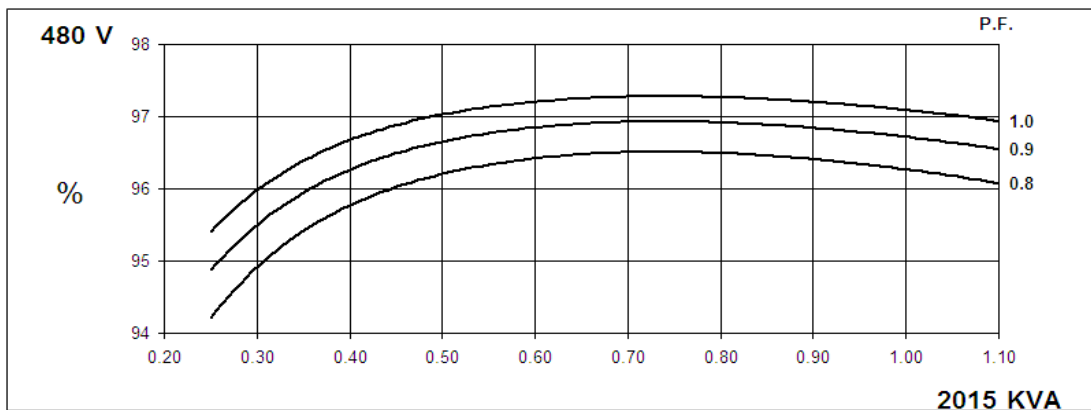
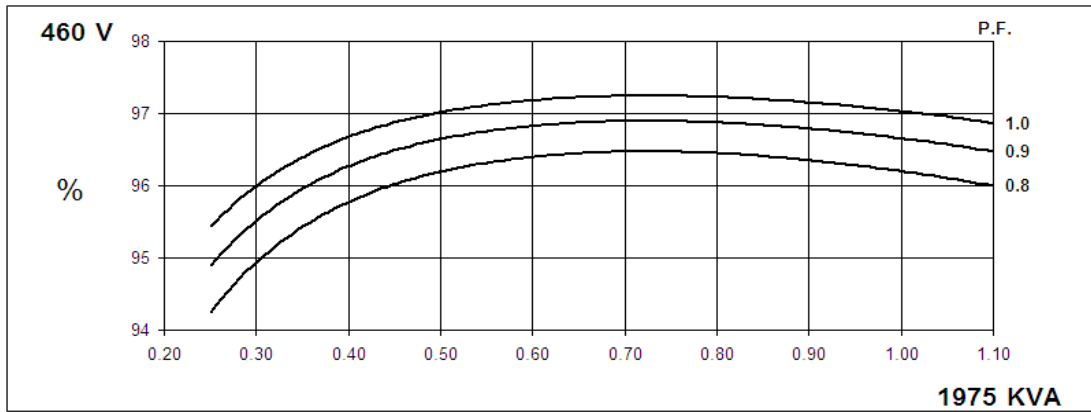
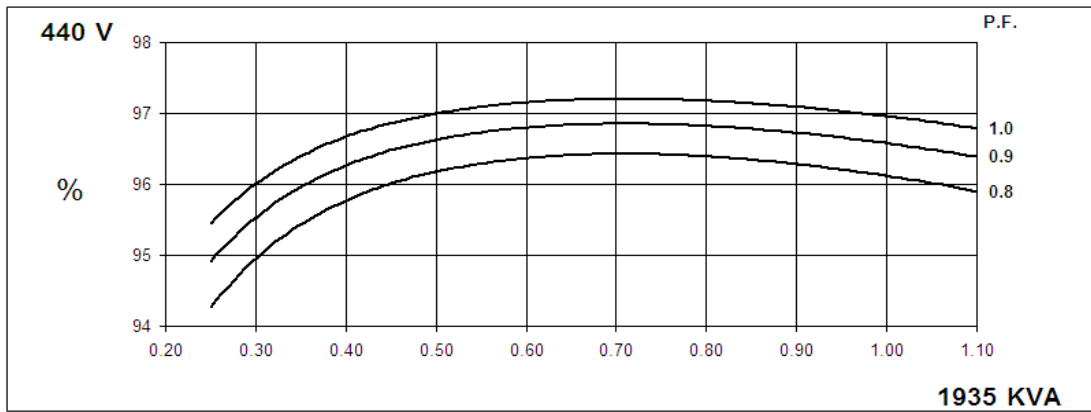
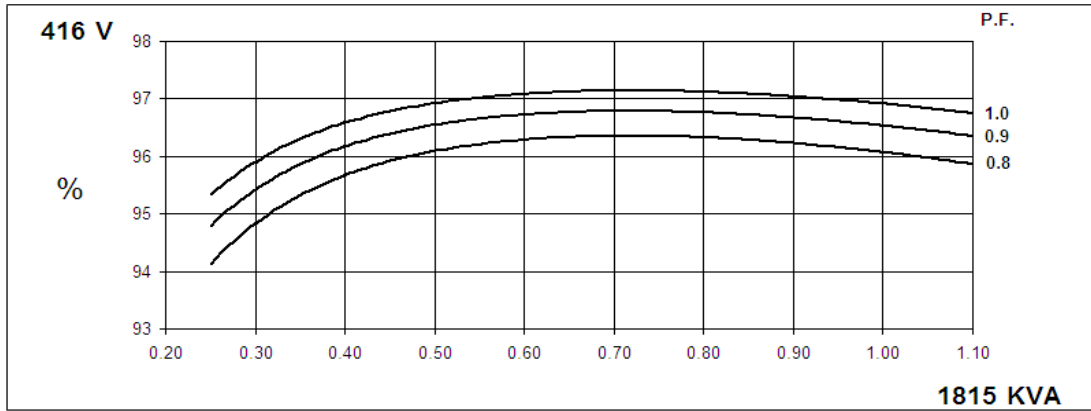

# PI734D

## Winding 312



### Locked Rotor Motor Starting Curve

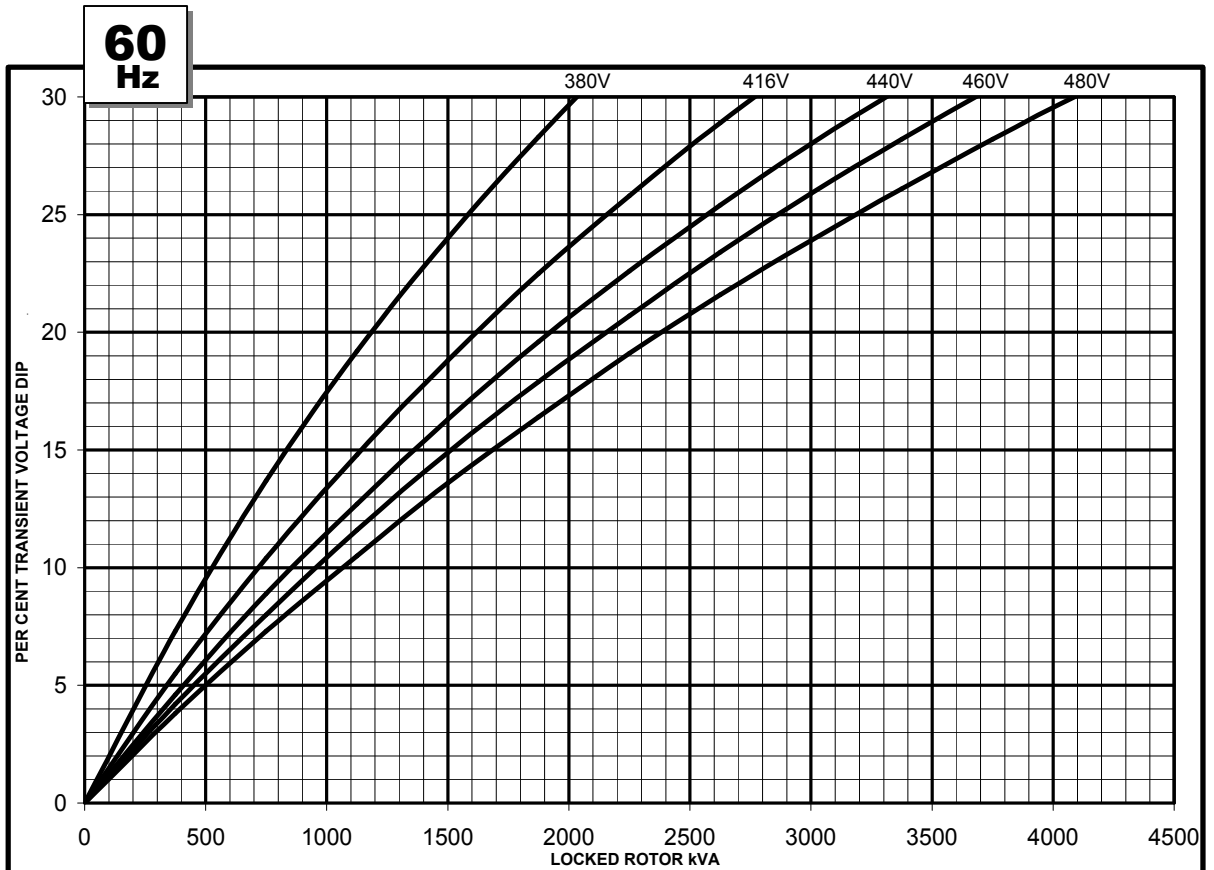
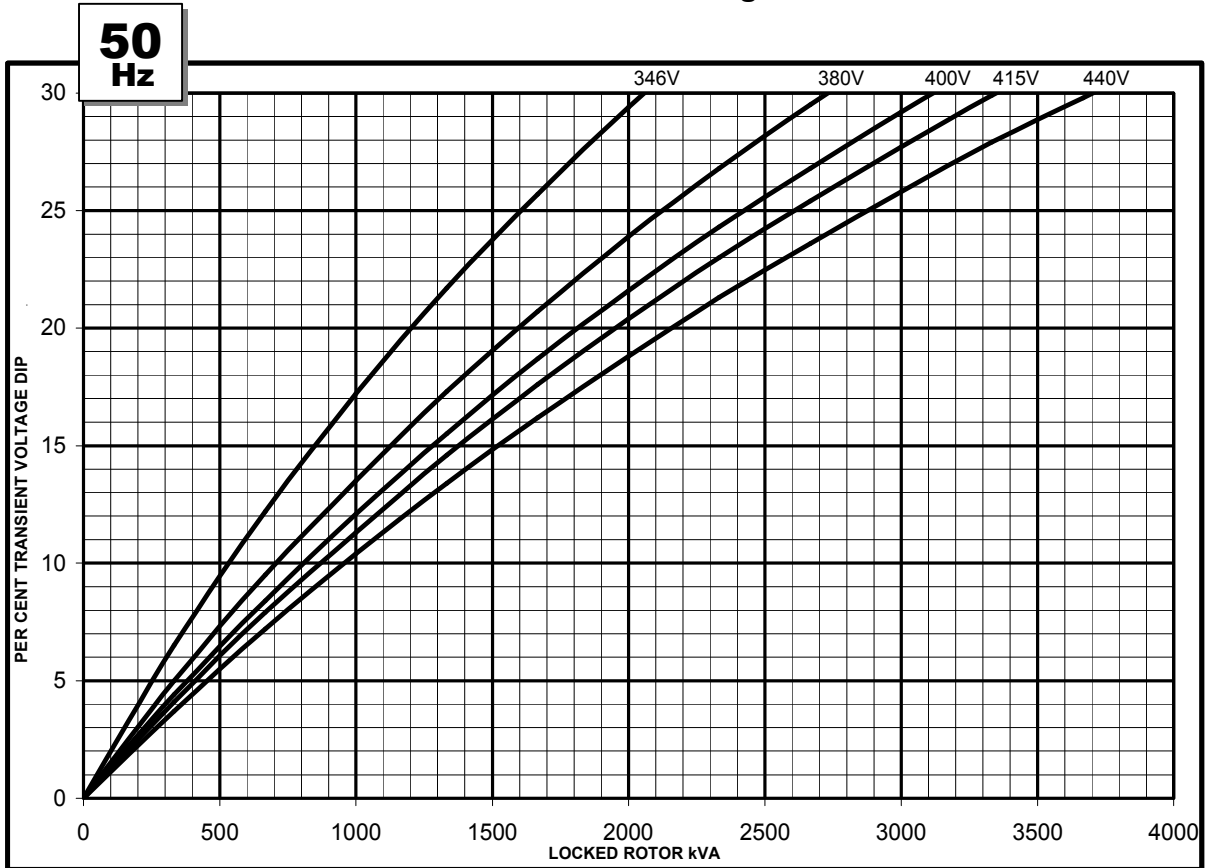

**Three-phase Short Circuit Decrement Curve. No-load Excitation at Rated Speed  
Based on star (wye) connection.**

**50  
Hz**

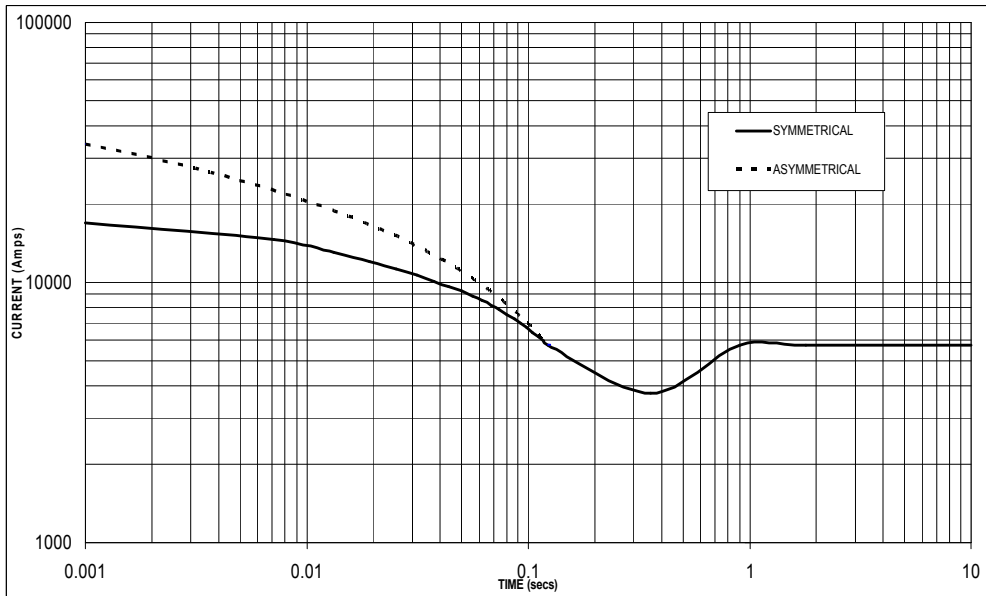

Sustained Short Circuit = 5,750 Amps

**60  
Hz**

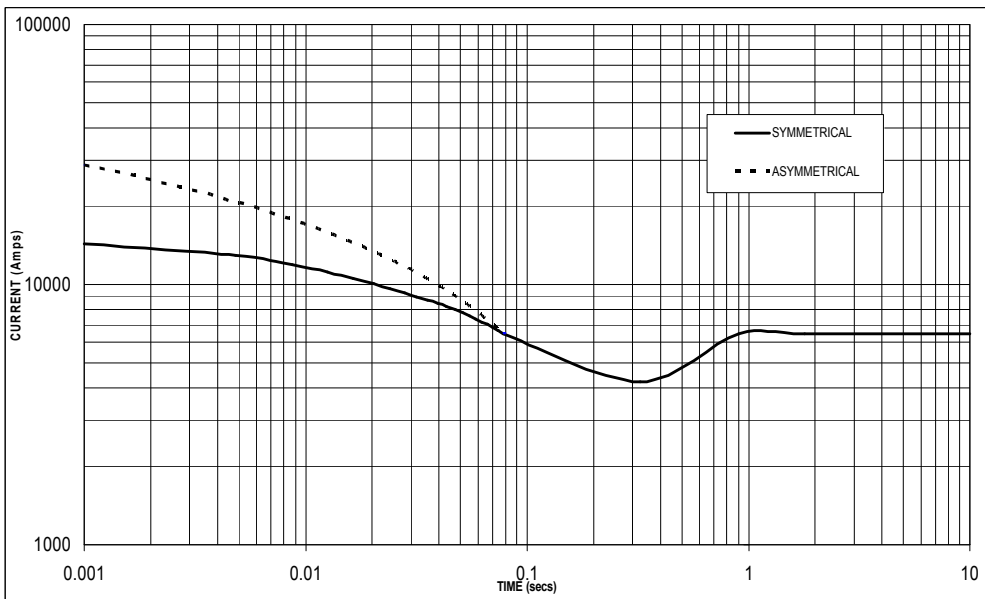

Sustained Short Circuit = 6,500 Amps

**Note 1**

The following multiplication factors should be used to adjust the values from curve between time 0.001 seconds and the minimum current point in respect of nominal operating voltage :

| 50Hz    |        | 60Hz    |        |
|---------|--------|---------|--------|
| Voltage | Factor | Voltage | Factor |
| 380v    | x 1.00 | 416v    | x 1.00 |
| 400v    | x 1.05 | 440v    | x 1.06 |
| 415v    | x 1.09 | 460v    | x 1.10 |
| 440v    | x 1.16 | 480v    | x 1.15 |

The sustained current value is constant irrespective of voltage level

**Note 2**

The following multiplication factor should be used to convert the values calculated in accordance with NOTE 1 to those applicable to the various types of short circuit :

|                         | 3-phase | 2-phase L-L | 1-phase L-N |
|-------------------------|---------|-------------|-------------|
| Instantaneous           | x 1.00  | x 0.87      | x 1.30      |
| Minimum                 | x 1.00  | x 1.80      | x 3.20      |
| Sustained               | x 1.00  | x 1.50      | x 2.50      |
| Max. sustained duration | 10 sec. | 5 sec.      | 2 sec.      |

All other times are unchanged

**Note 3**

Curves are drawn for Star (Wye) connected machines.

# PI734D

## Winding 312 / 0.8 Power Factor



### RATINGS

| Class - Temp Rise |                | Cont. F - 105/40°C |      |      |      | Cont. H - 125/40°C |      |      |      | Standby - 150/40°C |      |      |      | Standby - 163/27°C |      |      |      |
|-------------------|----------------|--------------------|------|------|------|--------------------|------|------|------|--------------------|------|------|------|--------------------|------|------|------|
| <b>50Hz</b>       | Star (V)       | 380                | 400  | 415  | 440  | 380                | 400  | 415  | 440  | 380                | 400  | 415  | 440  | 380                | 400  | 415  | 440  |
|                   | kVA            | 1500               | 1535 | 1535 | 1505 | 1615               | 1650 | 1650 | 1620 | 1675               | 1720 | 1720 | 1685 | 1715               | 1770 | 1770 | 1735 |
|                   | kW             | 1200               | 1228 | 1228 | 1204 | 1292               | 1320 | 1320 | 1296 | 1340               | 1376 | 1376 | 1348 | 1372               | 1416 | 1416 | 1388 |
|                   | Efficiency (%) | 96.2               | 96.3 | 96.4 | 96.5 | 96.1               | 96.2 | 96.3 | 96.4 | 96.0               | 96.1 | 96.2 | 96.3 | 95.9               | 96.0 | 96.1 | 96.3 |
|                   | kW Input       | 1247               | 1275 | 1274 | 1248 | 1344               | 1372 | 1371 | 1344 | 1396               | 1432 | 1430 | 1400 | 1431               | 1475 | 1473 | 1441 |

|             |                |      |      |      |      |      |      |      |      |      |      |      |      |      |      |      |      |
|-------------|----------------|------|------|------|------|------|------|------|------|------|------|------|------|------|------|------|------|
| <b>60Hz</b> | Star (V)       | 416  | 440  | 460  | 480  | 416  | 440  | 460  | 480  | 416  | 440  | 460  | 480  | 416  | 440  | 460  | 480  |
|             | kVA            | 1690 | 1800 | 1840 | 1875 | 1815 | 1935 | 1975 | 2015 | 1890 | 2015 | 2055 | 2100 | 1940 | 2070 | 2115 | 2160 |
|             | kW             | 1352 | 1440 | 1472 | 1500 | 1452 | 1548 | 1580 | 1612 | 1512 | 1612 | 1644 | 1680 | 1552 | 1656 | 1692 | 1728 |
|             | Efficiency (%) | 96.2 | 96.2 | 96.3 | 96.4 | 96.1 | 96.1 | 96.2 | 96.3 | 96.0 | 96.0 | 96.1 | 96.2 | 95.9 | 96.0 | 96.1 | 96.1 |
|             | kW Input       | 1405 | 1497 | 1529 | 1556 | 1511 | 1611 | 1642 | 1674 | 1575 | 1679 | 1711 | 1746 | 1618 | 1725 | 1761 | 1798 |

### DIMENSIONS

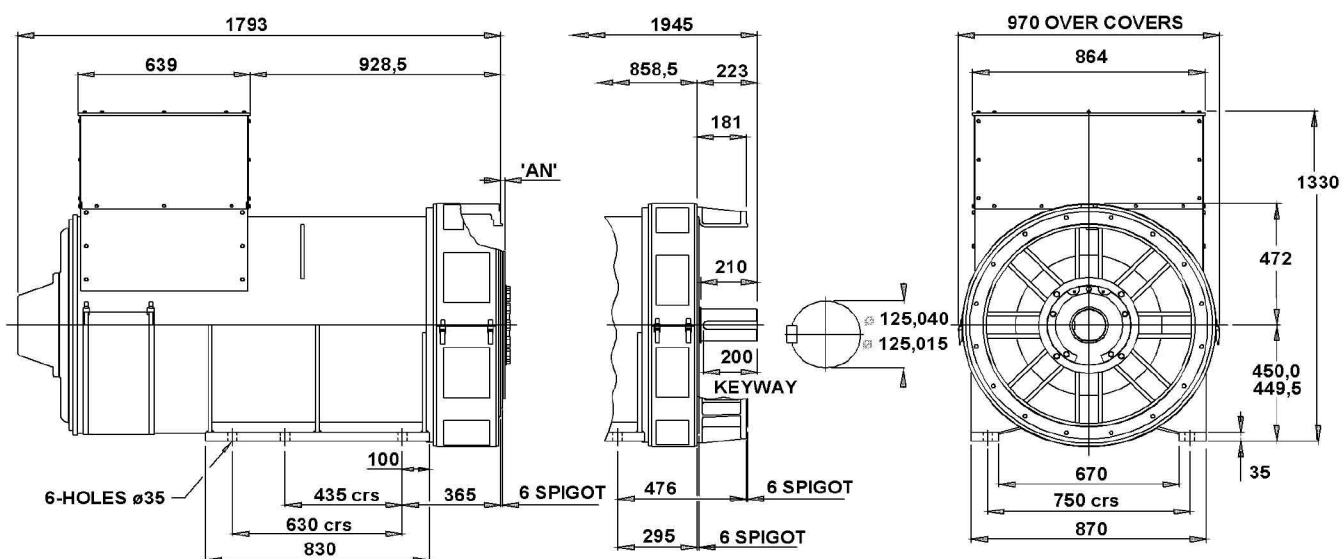

| COUPLING DISC | 'AN' |
|---------------|------|
| S.A.E No 18   | 15,7 |
| S.A.E No 21   | 0    |
| S.A.E No 24   | 0    |

| 1-BRG ADAPTORS |
|----------------|
| S.A.E No 0     |
| S.A.E No 00    |

| 2-BRG ADAPTORS |
|----------------|
| S.A.E No 0     |
| S.A.E No 00    |