

LVI634E - Technical Data Sheet

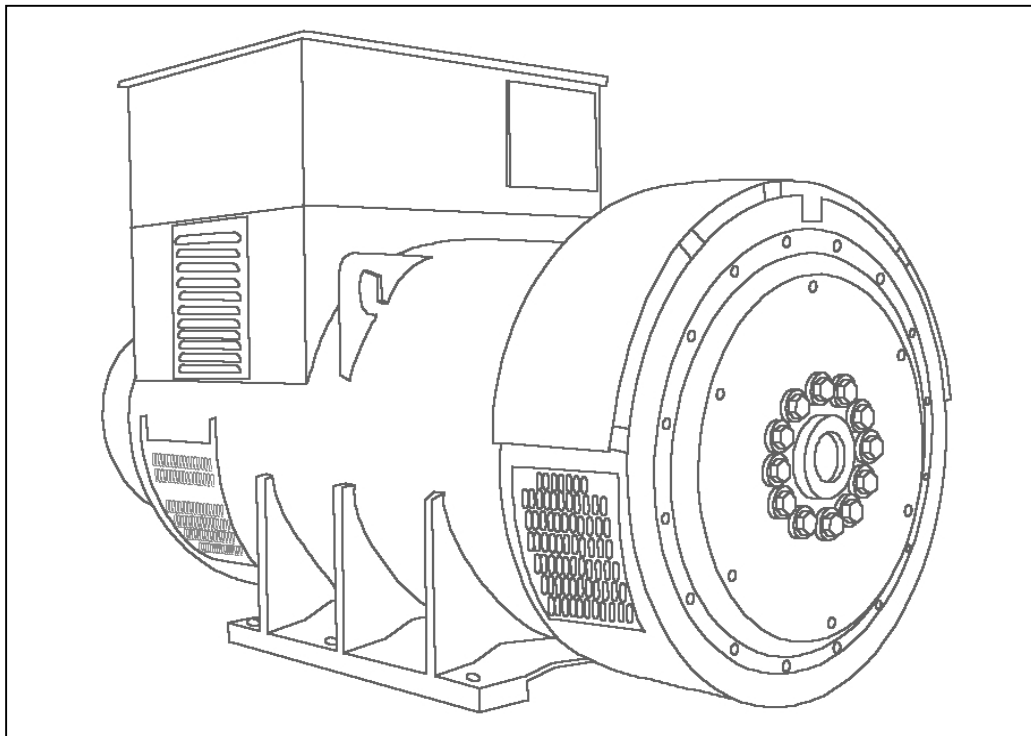

LVI634E

SPECIFICATIONS & OPTIONS



STANDARDS

Newage Stamford industrial generators meet the requirements of BS EN 60034 and the relevant section of other international standards such as BS5000, VDE 0530, NEMA MG1-32, IEC34, CSA C22.2-100, AS1359. Other standards and certifications can be considered on request.

VOLTAGE REGULATORS

MX341 AVR

This sophisticated AVR is incorporated into the Stamford Permanent Magnet Generator (PMG) control system.

The PMG provides power via the AVR to the main exciter, giving a source of constant excitation power independent of generator output. The main exciter output is then fed to the main rotor, through a full wave bridge, protected by a surge suppressor. The AVR has in-built protection against sustained over-excitation, caused by internal or external faults. This de-excites the machine after a minimum of 5 seconds.

An engine relief load acceptance feature can enable full load to be applied to the generator in a single step.

If three-phase sensing is required with the PMG system the MX321 AVR must be used.

We recommend three-phase sensing for applications with greatly unbalanced or highly non-linear loads.

MX321 AVR

The most sophisticated of all our AVRs combines all the features of the MX341 with, additionally, three-phase rms sensing, for improved regulation and performance.

Over voltage protection is built-in and short circuit current level adjustments is an optional facility.

WINDINGS & ELECTRICAL PERFORMANCE

All generator stators are wound to 2/3 pitch. This eliminates triplen (3rd, 9th, 15th ...) harmonics on the voltage waveform and is found to be the optimum design for trouble-free supply of non-linear loads. The 2/3 pitch design avoids excessive neutral currents sometimes seen with higher winding pitches, when in parallel with the mains. A fully connected damper winding reduces oscillations during paralleling. This winding, with the 2/3 pitch and carefully selected pole and tooth designs, ensures very low waveform distortion.

TERMINALS & TERMINAL BOX

Standard generators feature a main stator with 6 ends brought out to the terminals, which are mounted on the frame at the non-drive end of the generator. A sheet steel terminal box contains the AVR and provides ample space for the customers' wiring and gland arrangements. It has removable panels for easy access.

SHAFT & KEYS

All generator rotors are dynamically balanced to better than BS6861:Part 1 Grade 2.5 for minimum vibration in operation. Two bearing generators are balanced with a half key.

INSULATION/IMPREGNATION

The insulation system is class 'H'.

All wound components are impregnated with materials and processes designed specifically to provide the high build required for static windings and the high mechanical strength required for rotating components.

QUALITY ASSURANCE

Generators are manufactured using production procedures having a quality assurance level to BS EN ISO 9001.

The stated voltage regulation may not be maintained in the presence of certain radio transmitted signals. Any change in performance will fall within the limits of Criteria 'B' of EN 61000-6-2:2001. At no time will the steady-state voltage regulation exceed 2%.

NB Continuous development of our products entitles us to change specification details without notice, therefore they must not be regarded as binding.

Front cover drawing typical of product range.

LVI634E WINDING 312

CONTROL SYSTEM SER.3		SEPARATELY EXCITED BY P.M.G.						
A.V.R.	MX341	MX321						
VOLTAGE REGULATION	± 1.0 %	± 0.5 %	With 4% Engine Governing					
SUSTAINED SHORT CIRCUIT		REFER TO SHORT CIRCUIT DECREMENT CURVES (page 7)						
INSULATION SYSTEM		CLASS H						
PROTECTION		IP23						
RATED POWER FACTOR		0.8						
STATOR WINDING		DOUBLE LAYER LAP						
WINDING PITCH		TWO THIRDS						
WINDING LEADS		6						
STATOR WDG. RESISTANCE (L-L)		0.0024 Ohms PER PHASE AT 22°C STAR CONNECTED						
ROTOR WDG. RESISTANCE		1.92 Ohms at 22°C						
R.F.I. SUPPRESSION		BS EN 61000-6-2 & BS EN 61000-6-4, VDE 0875G, VDE 0875N. refer to factory for others						
WAVEFORM DISTORTION		NO LOAD < 1.5% NON-DISTORTING BALANCED LINEAR LOAD < 5.0%						
MAXIMUM OVERSPEED		2250 Rev/Min						
BEARING DRIVE END		BALL. 6228 (ISO)						
BEARING NON-DRIVE END		BALL. 6319 (ISO)						
	1 BEARING			2 BEARING				
WEIGHT COMP. GENERATOR	2394 kg			2395 kg				
WEIGHT WOUND STATOR	1021 kg			1021 kg				
WEIGHT WOUND ROTOR	885 kg			841 kg				
WR ² INERTIA	20.611 kgm ²			20.068 kgm ²				
SHIPPING WEIGHTS in a crate	2601 kg			2622 kg				
PACKING CRATE SIZE	194 x 92 x 147 (cm)			194 x 92 x 147 (cm)				
	50 Hz			60 Hz				
TELEPHONE INTERFERENCE	THF<2%			TIF<50				
COOLING AIR	2.18 m ³ /sec 4619 cfm			2.63 m ³ /sec 5573 cfm				
VOLTAGE STAR (Y)	380/220	400/231	415/240	440/254	416/240	440/254	460/266	480/277
KVA BASE RATING FOR REACTANCE VALUES	950	1000	1000	910	1083	1145	1197	1250
X _d DIR. AXIS SYNCHRONOUS	2.62	2.49	2.31	1.87	2.99	2.82	2.70	2.59
X' _d DIR. AXIS TRANSIENT	0.13	0.13	0.12	0.10	0.15	0.14	0.14	0.13
X'' _d DIR. AXIS SUBTRANSIENT	0.10	0.09	0.08	0.07	0.11	0.10	0.10	0.10
X _q QUAD. AXIS REACTANCE	2.18	2.07	1.92	1.56	2.49	2.35	2.25	2.16
X'' _q QUAD. AXIS SUBTRANSIENT	0.25	0.24	0.22	0.18	0.28	0.27	0.26	0.25
X _L LEAKAGE REACTANCE	0.06	0.06	0.06	0.05	0.07	0.07	0.07	0.06
X ₂ NEGATIVE SEQUENCE	0.17	0.16	0.15	0.12	0.20	0.19	0.18	0.17
X ₀ ZERO SEQUENCE	0.03	0.03	0.02	0.02	0.03	0.03	0.03	0.03
REACTANCES ARE SATURATED				VALUES ARE PER UNIT AT RATING AND VOLTAGE INDICATED				
T' _d TRANSIENT TIME CONST.	0.097 s							
T'' _d SUB-TRANSTIME CONST.	0.014 s							
T' _{do} O.C. FIELD TIME CONST.	3.18 s							
T _a ARMATURE TIME CONST.	0.034 s							
SHORT CIRCUIT RATIO	1/X _d							

**50
Hz**

LVI634E
Winding 312



THREE PHASE EFFICIENCY CURVES

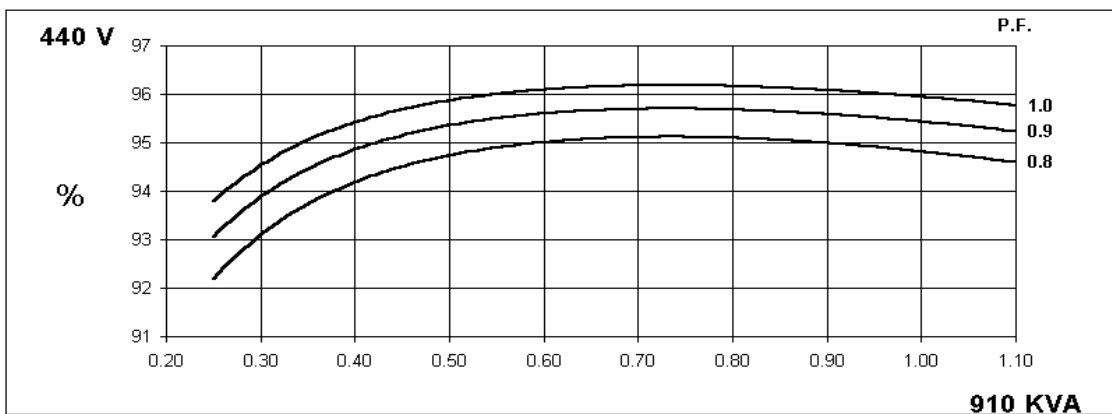
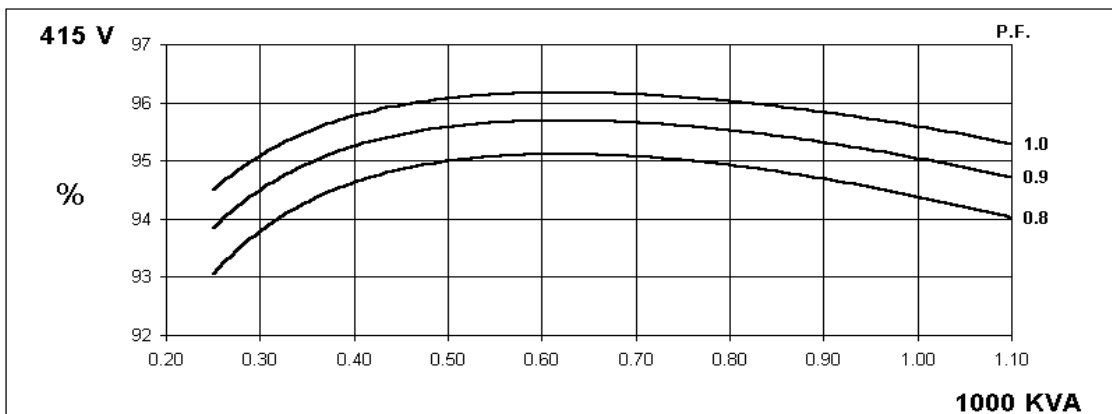
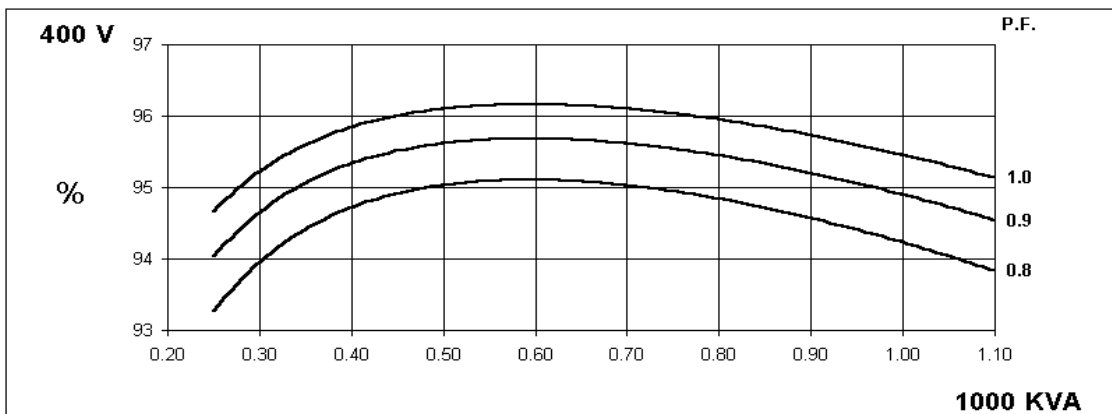
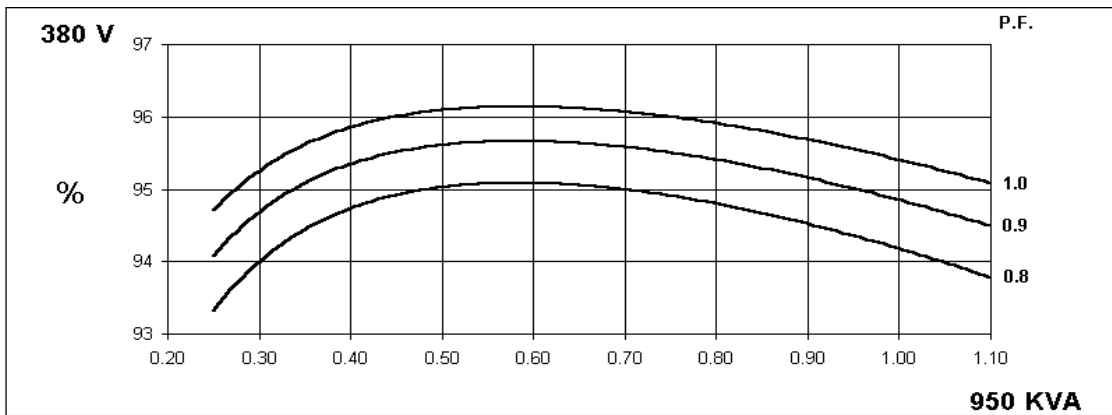

THREE PHASE EFFICIENCY CURVES

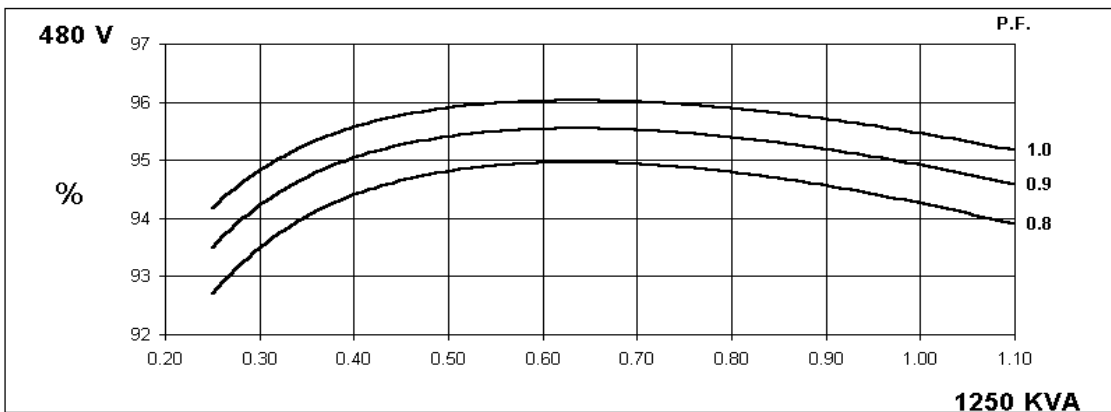
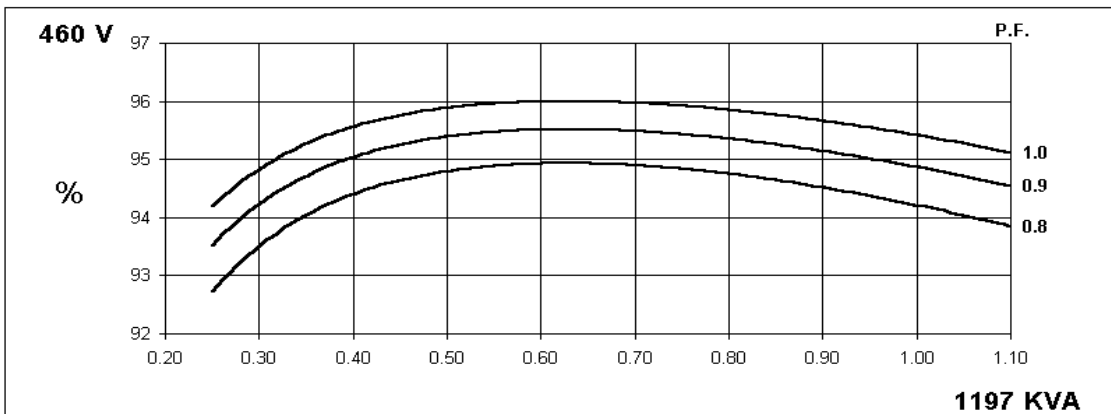
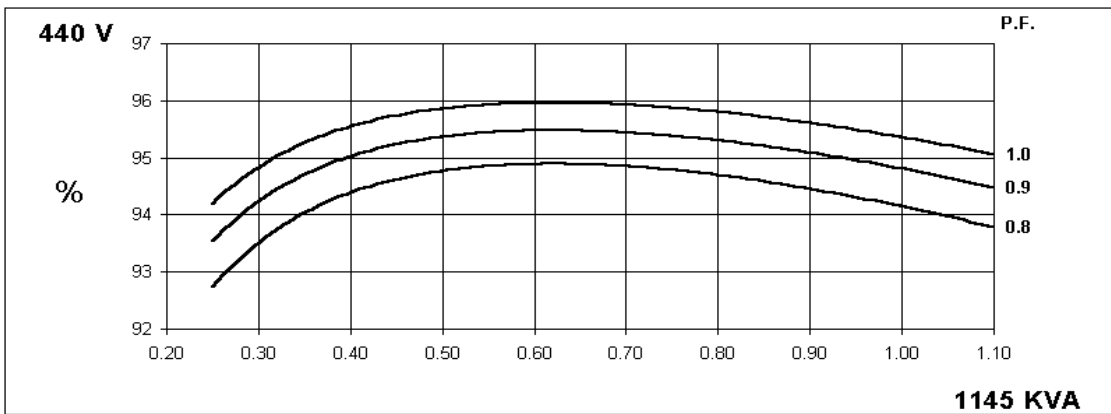
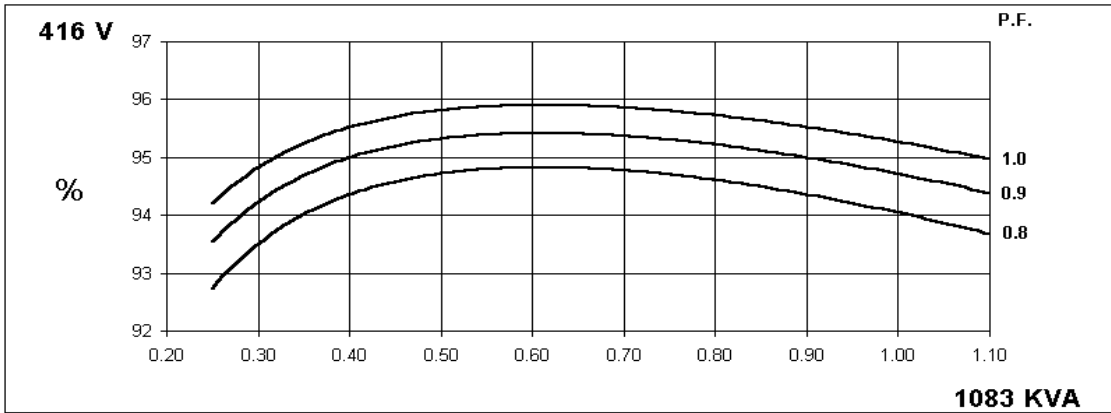

LVI634E

Winding 312



Locked Rotor Motor Starting Curve

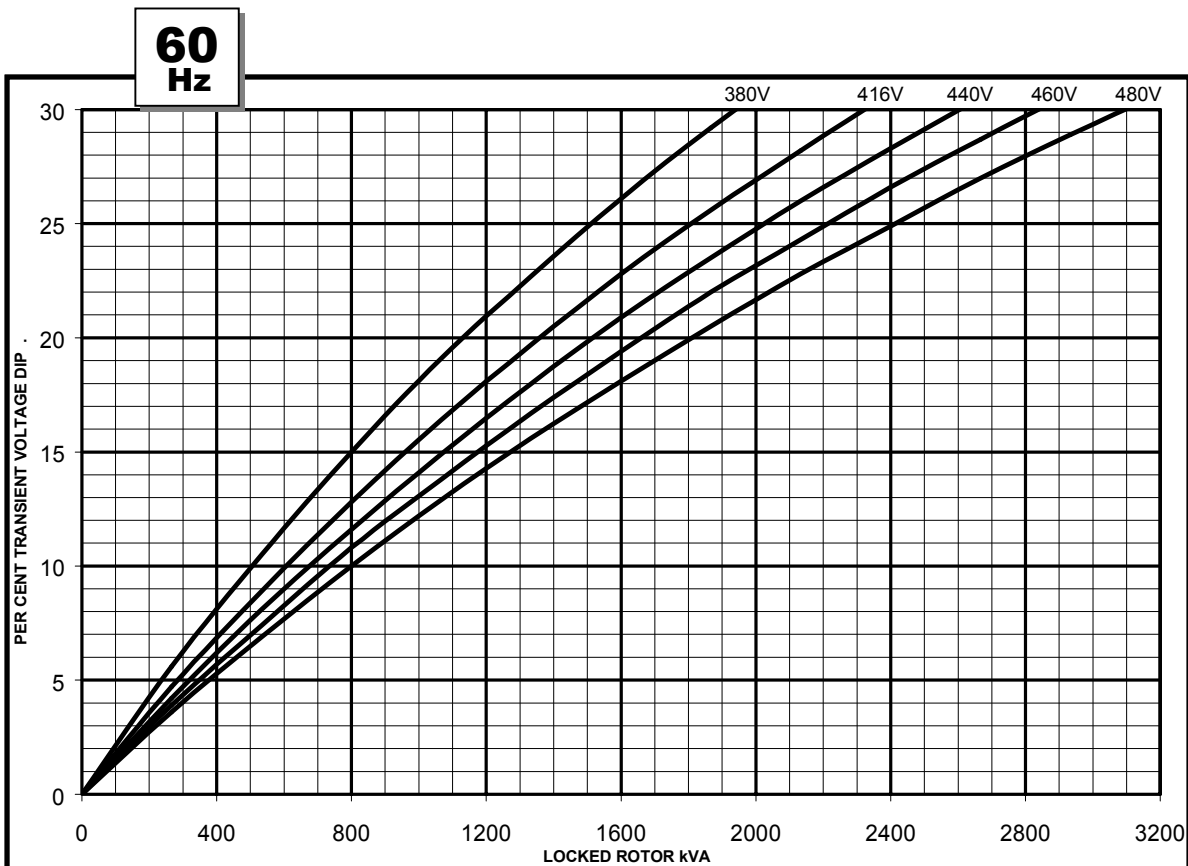
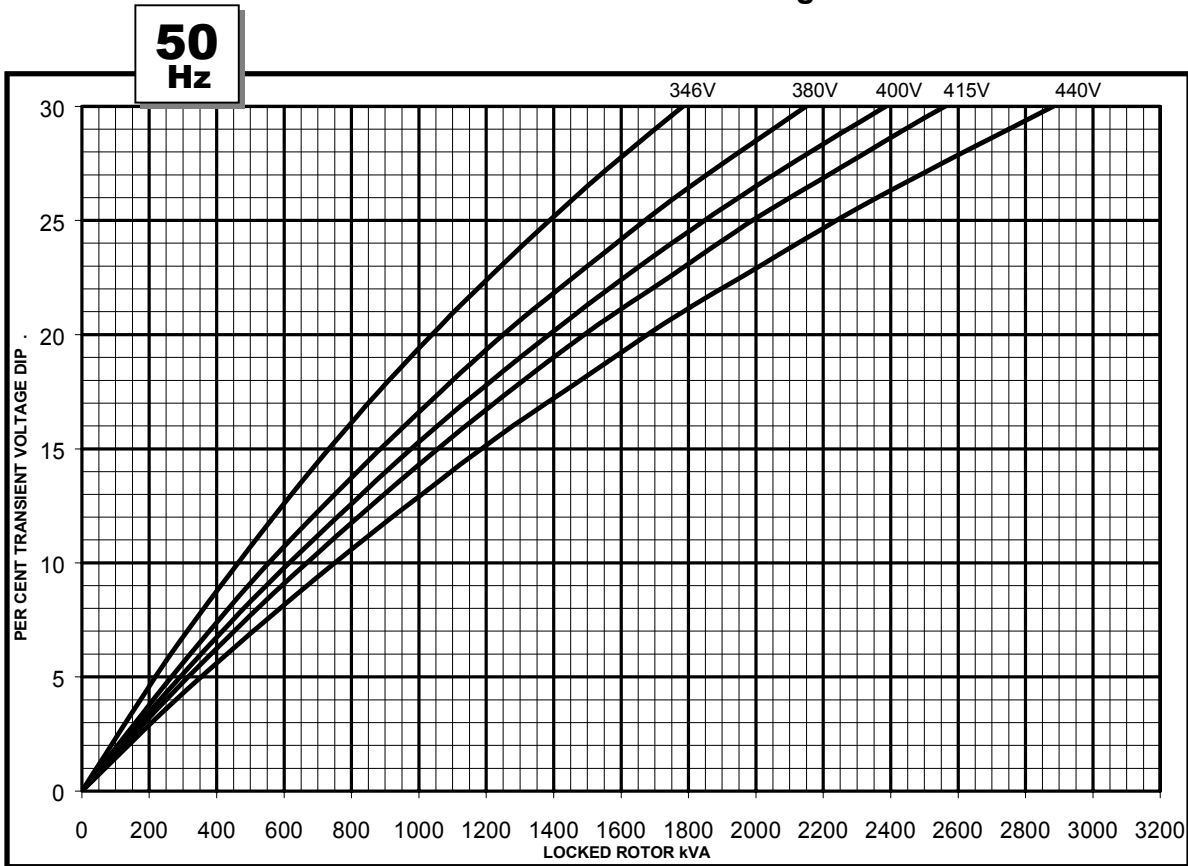

**Three-phase Short Circuit Decrement Curve. No-load Excitation at Rated Speed
Based on star (wye) connection.**

**50
Hz**

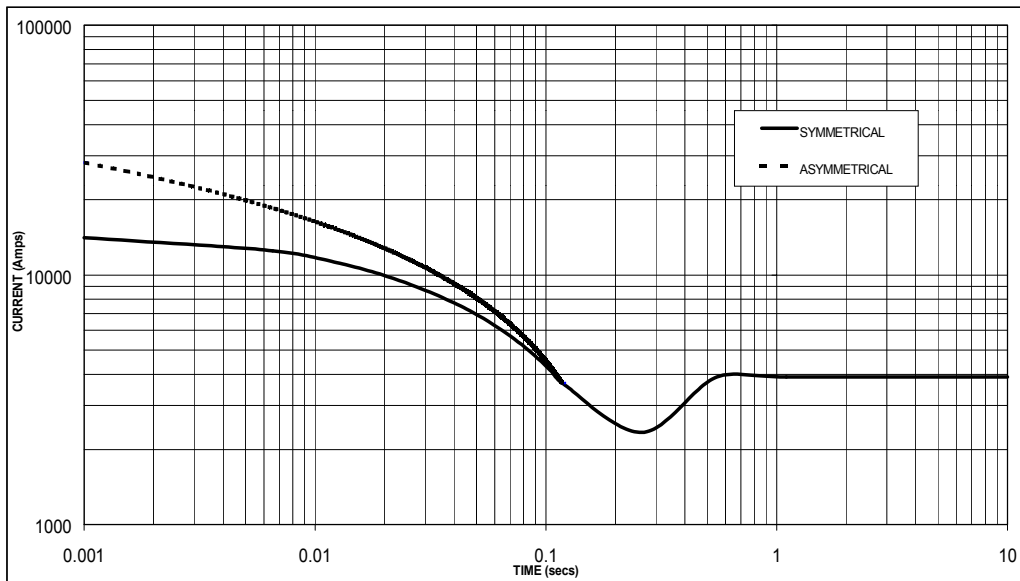

Sustained Short Circuit = 3,900 Amps

**60
Hz**

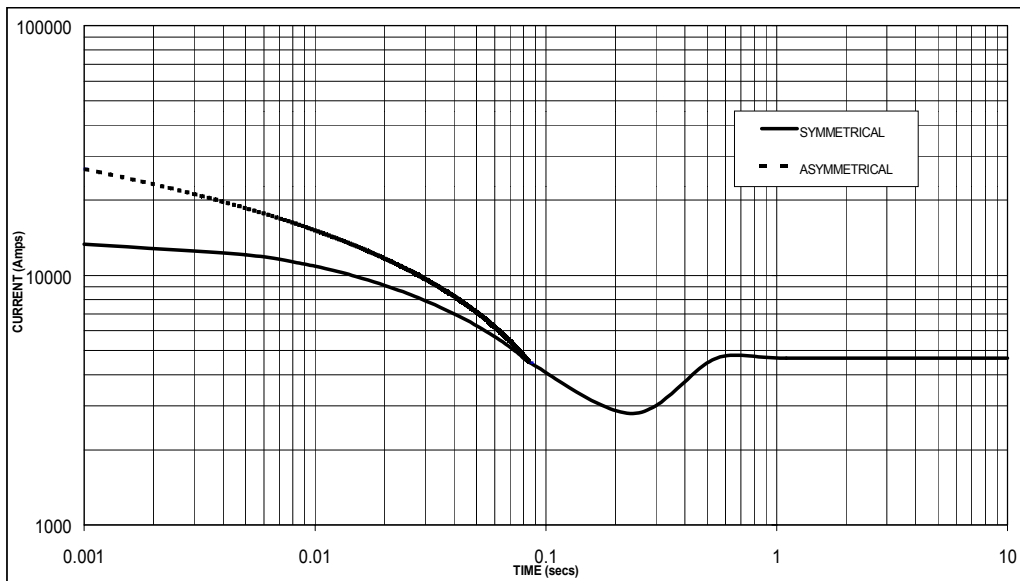

Sustained Short Circuit = 4,660 Amps

Note 1

The following multiplication factors should be used to adjust the values from curve between time 0.001 seconds and the minimum current point in respect of nominal operating voltage :

50Hz		60Hz	
Voltage	Factor	Voltage	Factor
380v	X 1.00	416v	X 1.00
400v	X 1.05	440v	X 1.06
415v	X 1.09	460v	X 1.10
440v	X 1.16	480v	X 1.15

The sustained current value is constant irrespective of voltage level

Note 2

The following multiplication factor should be used to convert the values calculated in accordance with NOTE 1 to those applicable to the various types of short circuit :

	3-phase	2-phase L-L	1-phase L-N
Instantaneous	x 1.00	x 0.87	x 1.30
Minimum	x 1.00	x 1.80	x 3.20
Sustained	x 1.00	x 1.50	x 2.50
Max. sustained duration	10 sec.	5 sec.	2 sec.

All other times are unchanged

Note 3

Curves are drawn for Star (Wye) connected machines.

LVI634E

Winding 312 / 0.8 Power Factor



RATINGS

Class - Temp Rise		Cont. F - 105/40°C				Cont. H - 125/40°C				Standby - 150/40°C				Standby - 163/27°C			
50 Hz	Star (V)	380	400	415	440	380	400	415	440	380	400	415	440	380	400	415	440
	Delta (V)	220	230	240	254	220	230	240	254	220	230	240	254	220	230	240	254
	kVA	871	917	917	834	950	1000	1000	910	980	1030	1030	938	1000	1050	1050	955
	kW	697	734	734	667	760	800	800	728	784	824	824	750	800	840	840	764
	Efficiency (%)	94.5	94.5	94.6	95.0	94.2	94.2	94.4	94.8	94.1	94.1	94.3	94.8	94.0	94.0	94.2	94.7
	kW Input	737	776	775	702	807	849	847	768	833	876	874	792	851	894	892	807

60 Hz	Star (V)	416	440	460	480	416	440	460	480	416	440	460	480	416	440	460	480
	Delta (V)	240	254	266	277	240	254	266	277	240	254	266	277	240	254	266	277
	kVA	990	1049	1097	1146	1083	1145	1197	1250	1118	1180	1236	1290	1130	1195	1250	1305
	kW	792	839	878	917	866	916	958	1000	894	944	989	1032	904	956	1000	1044
	Efficiency (%)	94.3	94.4	94.5	94.5	94.1	94.2	94.2	94.3	93.9	94.0	94.1	94.2	93.9	94.0	94.1	94.1
	kW Input	840	889	929	970	921	972	1017	1060	953	1004	1051	1096	963	1017	1063	1109

DIMENSIONS

